



Ingersoll Rand Industrial Technologies provides products, services and solutions that enhance our customers' energy efficiency, productivity and operations. Our diverse and innovative products range from complete compressed air systems, tools and pumps to material and fluid handling systems and environmentally friendly microturbines. We also enhance productivity through solutions created by Club Car®, the global leader in golf and utility vehicles for businesses and individuals.

www.air.ingersollrand.com

Distributed by:



Ingersoll Rand compressors are not designed, intended or approved for breathing air applications. Ingersoll Rand does not approve specialized equipment for breathing air applications and assumes no responsibility or liability for compressors used for breathing air service.

Nothing contained on these pages is intended to extend any warranty or representation, expressed or implied, regarding the product described herein. Any such warranties or other terms and conditions of sale of products shall be in accordance with Ingersoll Rand's standard terms and conditions of sale for such products, which are available upon request.

Product improvement is a continuing goal at Ingersoll Rand. Designs and specifications are subject to change without notice or obligation.



Ingersoll Rand

Rotary Screw Air Compressors
15-50 hp (11-37 kW)



Innovation

Reliability

Efficiency

Performance That Pays

Ingersoll Rand

Welcome to Ingersoll Rand's rotary air solutions, a higher standard of performance.

Boosting your company's profits was the main goal that Ingersoll Rand had in mind when designing our revolutionary line of integrated rotary screw air solutions.

So how can a compressed air system help you increase profitability? The answer is really pretty simple: by ensuring that you achieve the highest productivity in your shop while reducing the total costs of ownership to the absolute lowest levels.

Our rotary screw compressors are more than integrated air systems; they are complete air solutions designed to maximize the key drivers of profitability in today's business:

- Ultimate reliability
- Flexibility of operation
- Shop productivity
- Energy efficiency and savings





Exceptional Value

Ultimate Reliability

Fewer Connections

- Smart integration eliminates leaks and pressure drops, maximising reliability.

Ultimate Efficiency

More Air for Your Money

- Industry-leading performance delivers more air for less horsepower, saving money on your energy bills.

Smart, Energy-efficient Controls

- Smart, energy-efficient controls eliminate wasteful unloaded running by unloading rapidly and by cycling the compressor on/off when not needed.

Ultimate Flexibility

Compact Footprint

- Receiver mounting frees up valuable floor space and reduces installation costs.

Installation Close to Point-of-Use

- Whisper-quiet operation allows for installation closer to point-of-use, reducing costs and ensuring a better, safer work environment.

Ultimate Productivity

Closely Maintained Pressure

- Reducing discharge pressure and avoiding excessive pressure bands increases downstream tool and equipment life.



Innovation

High-efficiency Integrated Compression Module

To provide maximum performance, efficiency and ease of service, the airend, interconnecting piping and separation system have all been integrated into one simple design. Integration of the high-efficiency compression module eliminates leaks and pressure losses to increase efficiency and performance.

Service and maintenance are made extremely simple through spin-on filtration and separator cartridges.

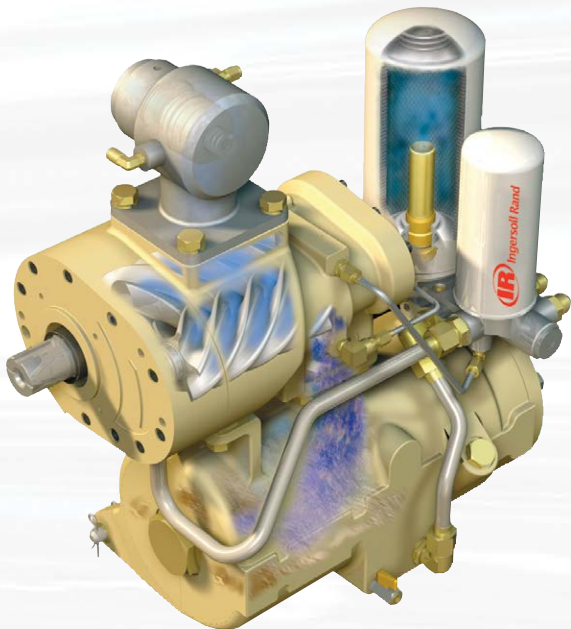

Real World Advantages

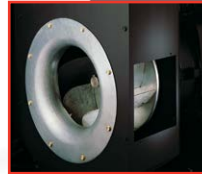

Whisper-quiet Operation

Oversized, high-efficiency cooling air blower provides sound levels as low as 67 dB(A).



Dual-control Operation

Reliable and effective load/no-load control with automatic stop and restart facility for maximum flexibility.



Simple Diagnostics

Visual indication of operating status and hours run for ease of operation and reduced downtime.

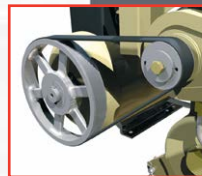

Poly-V Belt Drive

Premium drive system applies patented automatic tensioning to eliminate belt stretch and increase air output.



Advanced Cooling

A package pre-filter, efficient combination aftercooler with access to both sides for easy cleaning and top discharge to simplify ducting.



Generous Serviceability

All key maintenance components have been grouped to provide ease of serviceability.

Integral Air Treatment for 15-30 hp (11-22 kW)

High-efficiency Filter Pack

Clean Air to Drive Productivity

- Deep-bed general purpose filtration to deliver best performance, reduce pressure losses and extend operating life.
- Particulate removal to industry-leading 1 micron.
- Longer element life, lower pressure drop.
- Better air quality delivered to tools and equipment results in longer life.
- Prepares air for further treatment to meet specific requirements.

Energy-saving Refrigerated Air Dryer

Dry Air to Drive Productivity

- High-efficiency direct expansion refrigerated dryer automatically starts with the compressor and operates continually. This operating cycle ensures immediate drying, reactive to the compressor loads. The dryer operates until the compressor unit is shut down.
- Simple coiled tube-in-tube heat exchanger is selected at this size of unit to achieve optimum performance, with low losses, high thermal efficiency and long service life.
- Highly efficient centrifugal moisture separator with timed solenoid drain valve permanently discharges condensate.
- Eliminates corrosion of piping – a cause of premature wear of tools and seals.

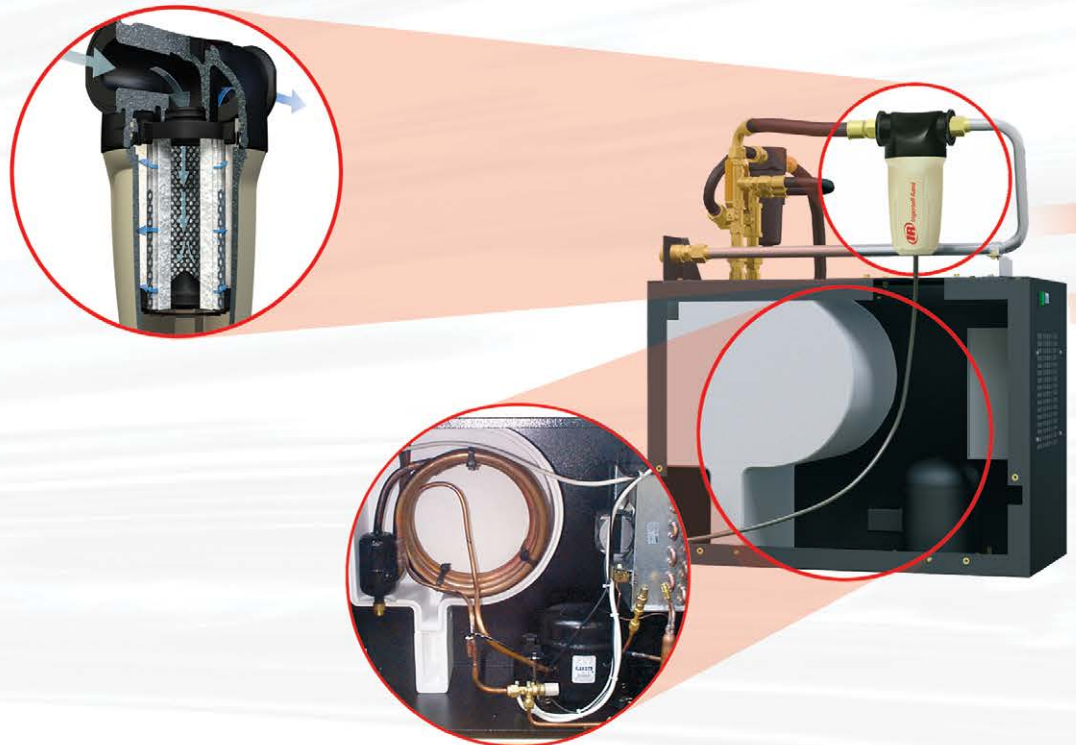

Smart Integration for 15-30 hp (11-22 kW)

Advanced Packaging to Drive Reliability and Uptime

- “Dry” air receiver mounted in a compact package lowers the cost of installation (optional floor mount also available).
- Integral air cooling with separate flow paths ensure cooling is achieved 100% of the time that the compressor is running.
- Easy access to all compressor and air treatment components, promoting serviceability.
- Package pre-filter for longer component life and reduced maintenance cost.
- Simplified piping eliminates potential leaks.
- Single-point condensate drain system instead of separate points reduces installation cost.
- Segregated cooling compartment provides advanced cooling flow management and reduces noise level.



Intellisys® Control Option

Probably the best-known name in compressor control systems, the optional Intellisys® Control offers precise pressure control, energy saving functions and advanced asset protection. Intellisys is available for our entire product line from 15-50 hp (11-37kW).

Other Practical Options and Kits

- Floor mounted
- Compressor package without air treatment equipment
- Weather-resistant enclosure
- NEMA4/IP55 package with TEFC (Totally Enclosed, Fan-Cooled) motor
- PORO (Power Outage Restart Option) to safely restore machine following power interruption
- Frost protection (not available for units with refrigerant dryer)
- Upper range modulation control
- Sequence controllers
- Pace system pressure regulators

Integral Air Treatment for 30-50 hp (22-37 kW)

Modular Cross Flow Heat Exchanger

Leading Technology Driving Efficiency

At the heart of the dryer lies the specially designed cross flow heat exchanger module, incorporating air-to-air and air-to-refrigerant heat exchangers as well as a high-efficiency stainless steel de-mister condensate separator, all in one compact unit.

Pre-cooling reduces the refrigeration load by as much as 60%. Air is further cooled through refrigerant heat exchange. Moisture is removed by the de-mister, close-coupled to the evaporator.

The cross flow heat exchanger incurs minimum air pressure losses while ensuring efficient water removal.

Energy-saving Refrigerated Air Dryer

Dry Air to Drive Productivity

- Direct expansion – refrigeration dryer simply and reliably dries the compressed air whenever the machine is loaded.
- Composite welded aluminium heat exchanger for low losses, high thermal efficiency and long service life.
- Solenoid drain valve and high-efficiency moisture separator to permanently discharge condensate.
- Eliminates corrosion of piping – a cause of premature wear of tools and seals.

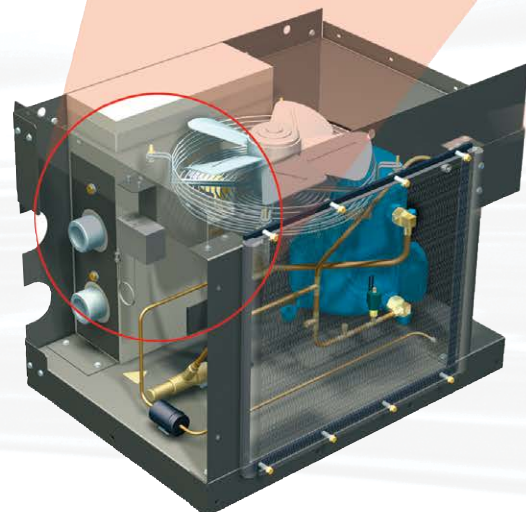
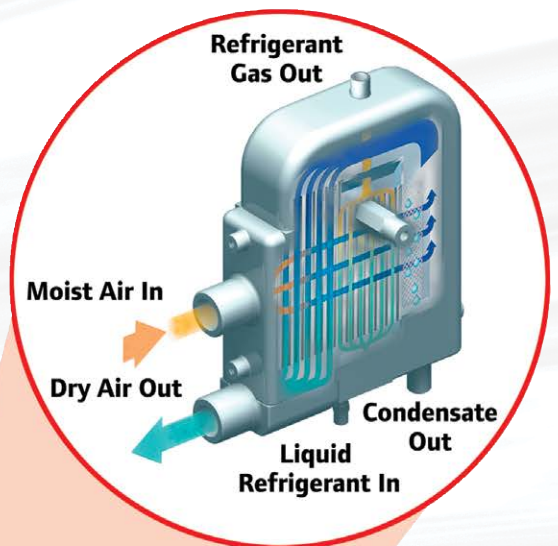

Smart Integration for 30, 40 and 50 hp (22, 30 and 37 kW)

Advanced Packaging to Drive Reliability and Uptime

- Floor mounted units only (a wide range of free-standing receivers are optionally available).
- Integral air cooling with separate flow paths ensure cooling is achieved 100% of the time that the compressor is running.
- Spacious design simplifies access and promotes serviceability.
- Package pre-filter for longer component life and reduced maintenance cost.
- Simplified piping eliminates potential leaks.
- Single-point condensate drain system instead of separate points reduces installation cost.
- Optional supply without dryer installation.

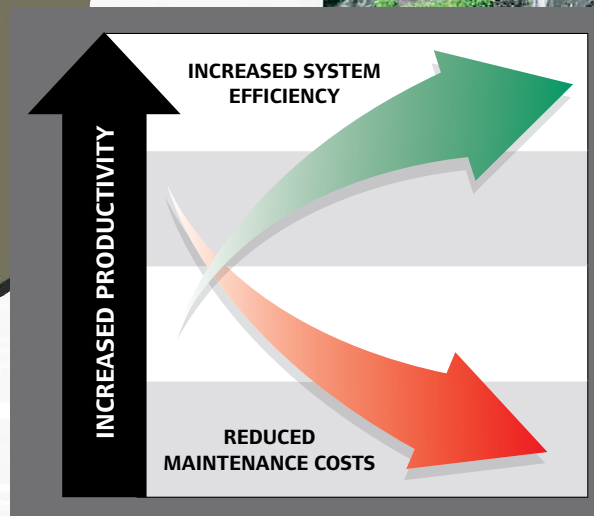
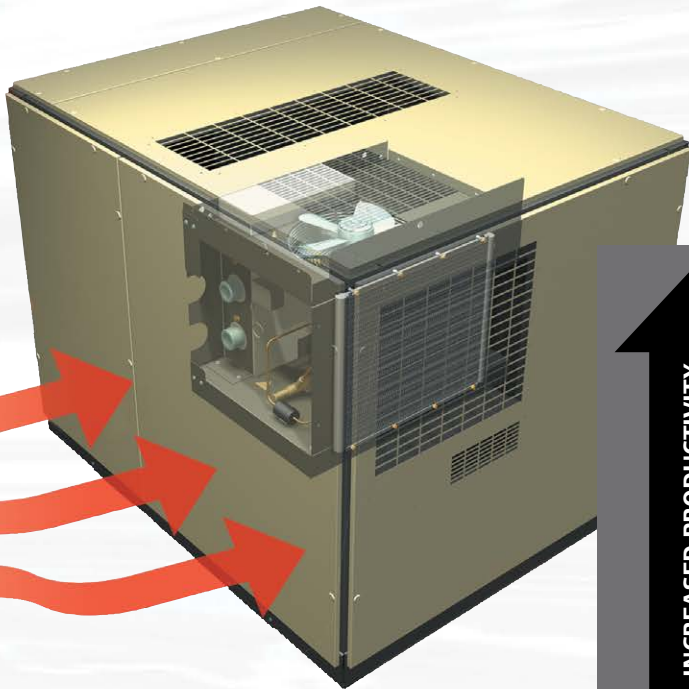

Progress is greener with Ingersoll Rand

Ingersoll Rand offers industry-leading products and solutions that enable businesses around the world to reduce energy consumption and costs and decrease harmful environmental emissions. From air compressors that reduce energy consumption to electric-powered golf cars with near-zero emissions, Ingersoll Rand provides the knowledge, experience and solutions to help our clients achieve their sustainability goals.



Local Customer Support

There is More to Value than Simply Price

The commitment of many thousands of dedicated compressed air specialists, either directly employed or members of a select market channel partnership, mean that friendly Ingersoll Rand support is close at hand. In addition to parts availability, qualified on-site service is available globally.



Ease of Service

No matter what the industry or location, Ingersoll Rand is committed to serving you 24 hours a day, seven days a week. Our worldwide network of distributors, engineers, and certified, factory-trained technicians, are a phone call away — ready to support you with innovative and cost-effective service solutions that will keep you running at peak performance.



Ultra Coolant™

Save cost with the advanced synthetic compressor coolant supplied as standard. Ultra Coolant™ reduces friction and wear, has a long operating life, has simple condensate separation characteristics and is biodegradable.



PackageCare is a service contract designed to help customers get the most out of their air system investment. Whether it's Ingersoll Rand equipment or a competitor's, a new compressor or used, with PackageCare customers get hassle-free system reliability, backed by the most comprehensive service program in the industry. We're the only OEM in the industry offering this type of service coverage.

PackageCare™

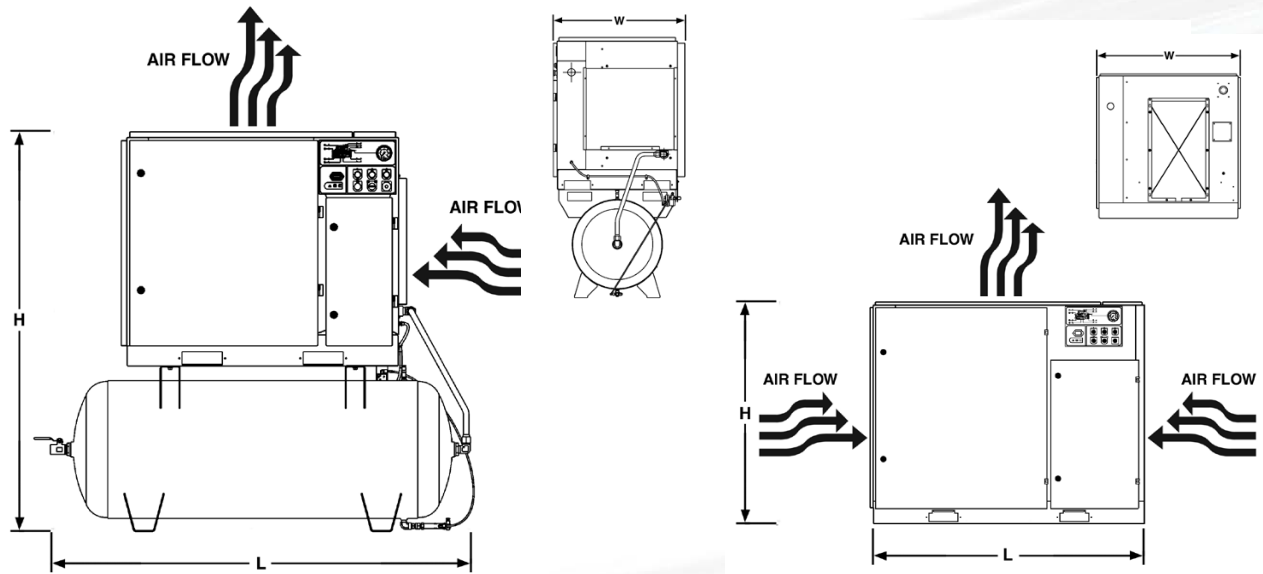

Specifications

Model	hp	kW	Capacity FAD		psig at Discharge		dB(A) [†]	Mounting	hp	Length	Width (inches)	Height	Weight (lbs)	
			m ³ /min ^{††}	cfm	before dryer	after dryer							without dryer	with dryer
UP6 15 125	15	11.0	1.84	65	125	120*	68+3	Standard Baseplate Package	15	50.6	36.2	41.3	1,142	–
UP6 15 150	15	11.0	1.64	58	150	145*	68+3		20	50.6	36.2	41.3	1,186	–
UP6 20 125	20	15.0	2.35	83	125	120*	68+3		25	50.6	36.2	41.3	1,206	–
UP6 20 150	20	15.0	2.12	75	150	145*	68+3		30	50.6	36.2	41.3	1,292	–
UP6 20 200	20	15.0	1.64	58	200	195*	68+3		40	67.4	54.3	52.9	2,436	–
									50	67.4	54.3	52.9	2,476	–
UP6 25 125	25	18.5	2.89	102	125	120*	68+3	Baseplate with Integral Air Treatment	15	67.0	36.2	41.3	–	1,367
UP6 25 150	25	18.5	2.61	92	150	145*	68+3		20	67.0	36.2	41.3	–	1,411
UP6 25 200	25	18.5	2.12	75	200	195*	68+3		25	67.0	36.2	41.3	–	1,451
UP6 30 125	30	22.0	3.54	125	125	120*	69+3		30	67.0	36.2	41.3	–	1,537
UP6 30 150	30	22.0	3.17	112	150	145*	69+3		40	67.4	54.3	52.9	–	2,686
UP6 30 200	30	22.0	2.61	92	200	195*	69+3		50	67.4	54.3	52.9	–	2,726
UP6 40 115	40	30.0	5.32	188	115	112 [‡]	69+3		Tank-mounted**	15	74.4	36.2	70.6	1,466
UP6 40 125	40	30.0	5.24	185	125	122 [‡]	69+3	120 Gallon Receiver	20	74.4	36.2	70.6	1,510	1,735
UP6 40 150	40	30.0	4.81	170	150	147 [‡]	69+3		25	74.4	36.2	70.6	1,530	1,775
UP6 40 200	40	30.0	4.05	143	200	N/A	69+3		30	74.4	36.2	70.6	1,616	1,861
UP6 50PE 115	50	37.0	6.02	212	115	112 [‡]	69+3	Tank-mounted**	15	91.2	36.2	76.4	1,735	1,960
UP6 50PE 125	50	37.0	5.89	208	125	122 [‡]	69+3		20	91.2	36.2	76.4	1,779	2,004
UP6 50PE 150	50	37.0	5.70	201	150	147 [‡]	69+3		25	91.2	36.2	76.4	1,799	2,044
UP6 50PE 200	50	37.0	4.73	167	200	N/A	69+3		30	91.2	36.2	76.4	1,885	2,130

*Maximum discharge pressure for package, which includes moisture separator, refrigerated dryer and installation with GP filter. Filtration efficiency to 1 micron for solid particles, liquids 0.5 mg/m³ W at 21 °C and condensate drains

‡Maximum discharge pressure for package, which includes moisture separator, refrigerated dryer, installation and condensate drains

††Capacity quoted tested in accordance with ISO 1217:1996 annex C (CAGI-pneurop PN2CPT2)

**Dimensions same for receiver mounted package either with or without dryer

†Sound levels per ISO 2151:2004 annex C

N/A indicates not available